

Quick Start Manual



Read the user's manual carefully before starting to use the unit.
Producer reserves the right to implement changes without prior notice.

Safety Information

- De-pressurize and vent system prior to installation or removal
- Confirm chemical compatibility before use
- **DO NOT** exceed maximum temperature or pressure specifications
- **ALWAYS** wear safety goggles or face-shield during installation and/or service
- **DO NOT** alter product construction



Warning | Caution | Danger

Indicates a potential hazard. Failure to follow all warnings may lead to equipment damage, or failure, injury, or death.



Do Not Use Tools

Use of tool(s) may damage product beyond repair and potentially void product warranty.



Note | Technical Notes

Highlights additional information or detailed procedure.



Please Ensure that the Instruments are Not Subjected to Water Hammer or Pressure Spikes & Always Pressure Test System with H2O Prior to Initial Start-Up!

Before installation be certain the appropriate instrument has been selected considering operating pressure, full scale pressure, wetted material requirements, media compatibility, operating temperature, vibration, pulsation, desired accuracy and any other instrument component related to the service application including the potential need for protective attachments and/or special installation requirements. Failure to do so could result in equipment damage, failure and/or personal injury. Ensure only qualified personnel are permitted to install and maintain this instrument.



Pressurize System Warning

Sensor may be under pressure, take caution to vent system prior to installation or removal. Failure to do so may result in equipment damage and/or serious injury.



Personal Protective Equipment (PPE)

Always utilize the most appropriate PPE during installation and service of Truflo® products.



Please Ensure Full Pipe

ProPulse® 2 Series can be installed in a horizontal or vertical direction. Please ensure enough length of straight pipe to avoid turbulence that can effect readings.

Product Description

The ProPulse® 2 Series provides superior performance and delivers accurate ultra-low flow measurement that is highly repeatable under the most demanding of industrial environments.

The ProPulse® 2 Series operates using a PP/PVDF rotor with encapsulated magnetic inserts, which rotate on a long-wearing set of zirconium ceramic bearings & rotor designed to provide years of reliability. As the rotor spins, the magnetic field produced by the magnets is picked up via a Hall Effect Sensor, which converts the rotation into a square wave NPN pulse, 4-20mA, IO-Link or RS485 output that can be sent directly to a metering pump, local display or PLC.

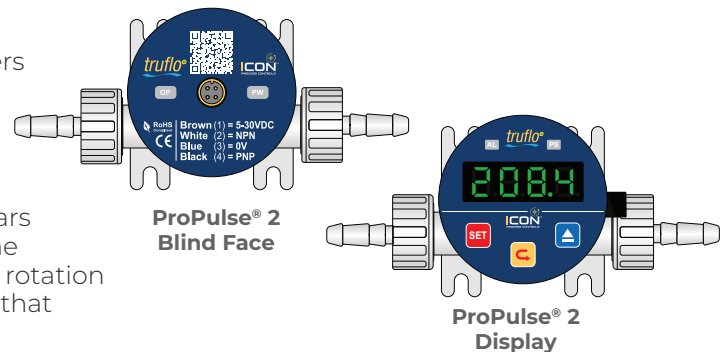

Application Example

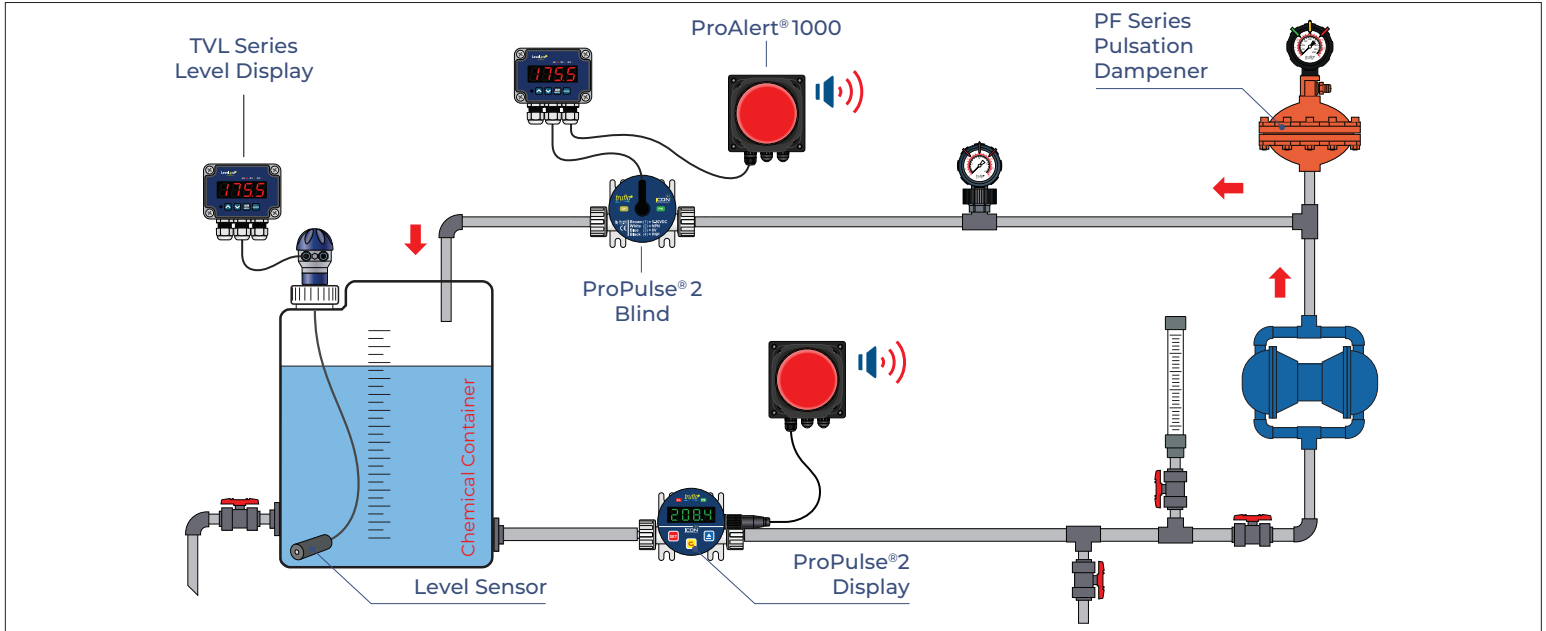

Technical Specifications

Body Material	PP PVDF	
O-Ring	Viton®	
Environmental Conditions	-4 to 176°F -20 to 80°C (35% – 85% RH)	
Operating Temperature	PP : -4 to 203°F -20 to 95°C	
	PVDF : -40 to 250°F -40 to 120°C	
Max. Working Pressure Non-Shock	PP: 145 Psi 10 Bar	PVDF: 217 Psi 15 Bar
Accuracy	± 1.0% of F.S. @ 25°C (PPW model) ± 0.5% of F.S. @ 25°C (PPM & PPR models)	
Output Current	PPW (Blind) 50mA max PPM & PPR (Display) 150mA max	
Operating Voltage	10 ~ 30 VDC (PPM & PPR models) 5 ~ 30 VDC (PPW model)	
Protection Class	NEMA 4X, IP65	
Display	4 digits: 0.0 – 9999 (PPM & PPR models)	

Features

- ✓ Excellent Chemical Resistance
- ✓ Perfect for Metering or Dosing Applications
- ✓ Ultra Low Flow Ranges | 40 ml/min | 0.01 GPM
- ✓ Variety of End Connections:
Hose Barb | Threaded | Flared | Straight Pipe
- ✓ Pulse | 4 – 20mA | RS485 | IO-Link
- ✓ Compact Lightweight Design
- ✓ 1/8" to 1/2" Sizes

PVDF Turbine

- ✓ Great Chemical Resistance
- ✓ Anti-Stick and Low Frictional Properties
- ✓ Superior Mechanical Properties

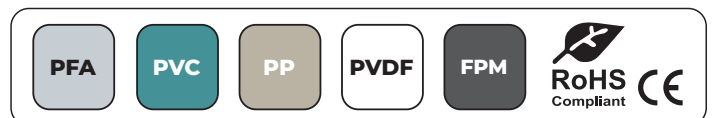

Truflo® — ProPulse® 2 Series

Mini Turbine Flow Meter

Wiring

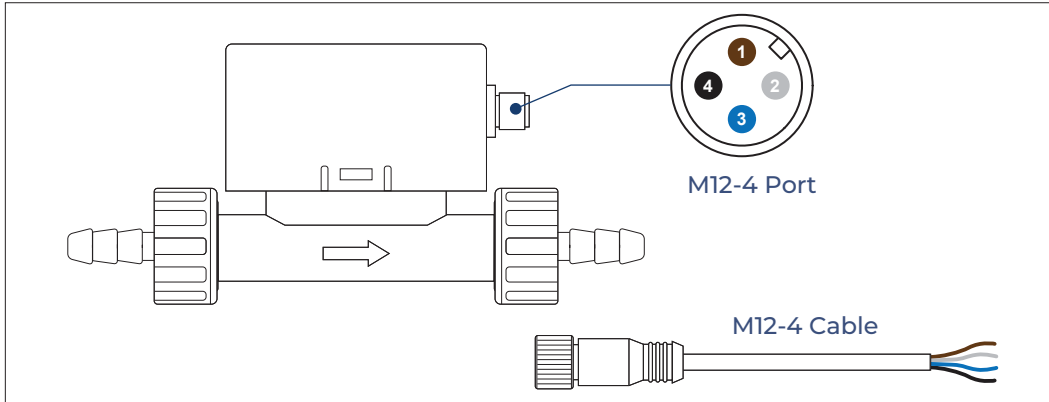

Flow Range

Connection	Flow Range (LPM)	Flow Range (GPM)	K Factor (LPM/GPM)
O2N 1/8" NPT	0.12 – 1.50	0.032 – 0.396	5,350
O3H 3/16" Hose Barb	0.04 – 2.20	0.010 – 0.581	5,350
O4T 1/4" Straight Tube	0.12 – 8.20	0.032 – 2.166	1,700
O4F 1/4" Flared	0.40 – 2.80	0.106 – 0.740	1,700
O6T 3/8" Straight Tube	0.12 – 16.20	0.032 – 4.280	875
O6H 3/8" Hose Barb	0.12 – 16.20	0.032 – 4.280	875
O6F 3/8" Flared	0.40 – 9.80	0.106 – 2.589	875

Dimensions

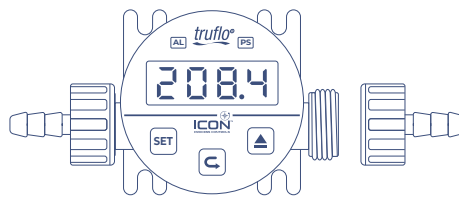
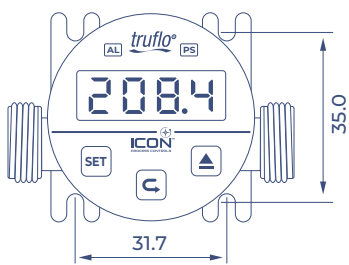

Hose Barb : O3H

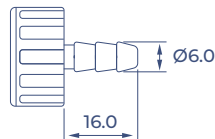

Hose Barb : O6H

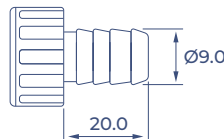

Straight Tube : O4T

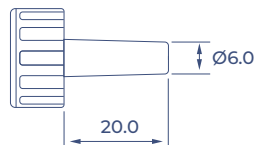

Straight Tube : O6T

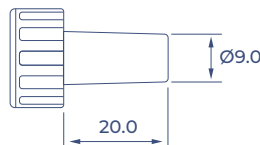

Electrical Connections

PPW – Blind (Pulse)

Pin	Color	Function
1	Brown	+ 5-30 VDC
2	White	NPN Output
3	Blue	0V
4	Black	PNP Output

PPR – Display (RS485)

Pin	Color	Function
1	Brown	+ 10-30 VDC
2	White	RS+
3	Blue	0V
4	Black	RS-

PPM – Display (4-20mA + Pulse)

Pin	Color	Function
1	Brown	+ 10-30 VDC
2	White	NPN Alarm Output
3	Blue	0V
4	Black	V+ or +mA Output

M12 Connection

(no internal wiring required)

Keyed to ensure correct connection

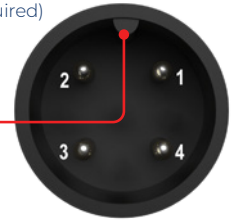

Truflo® — ProPulse® 2 Series Mini Turbine Flow Meter

Exploded View

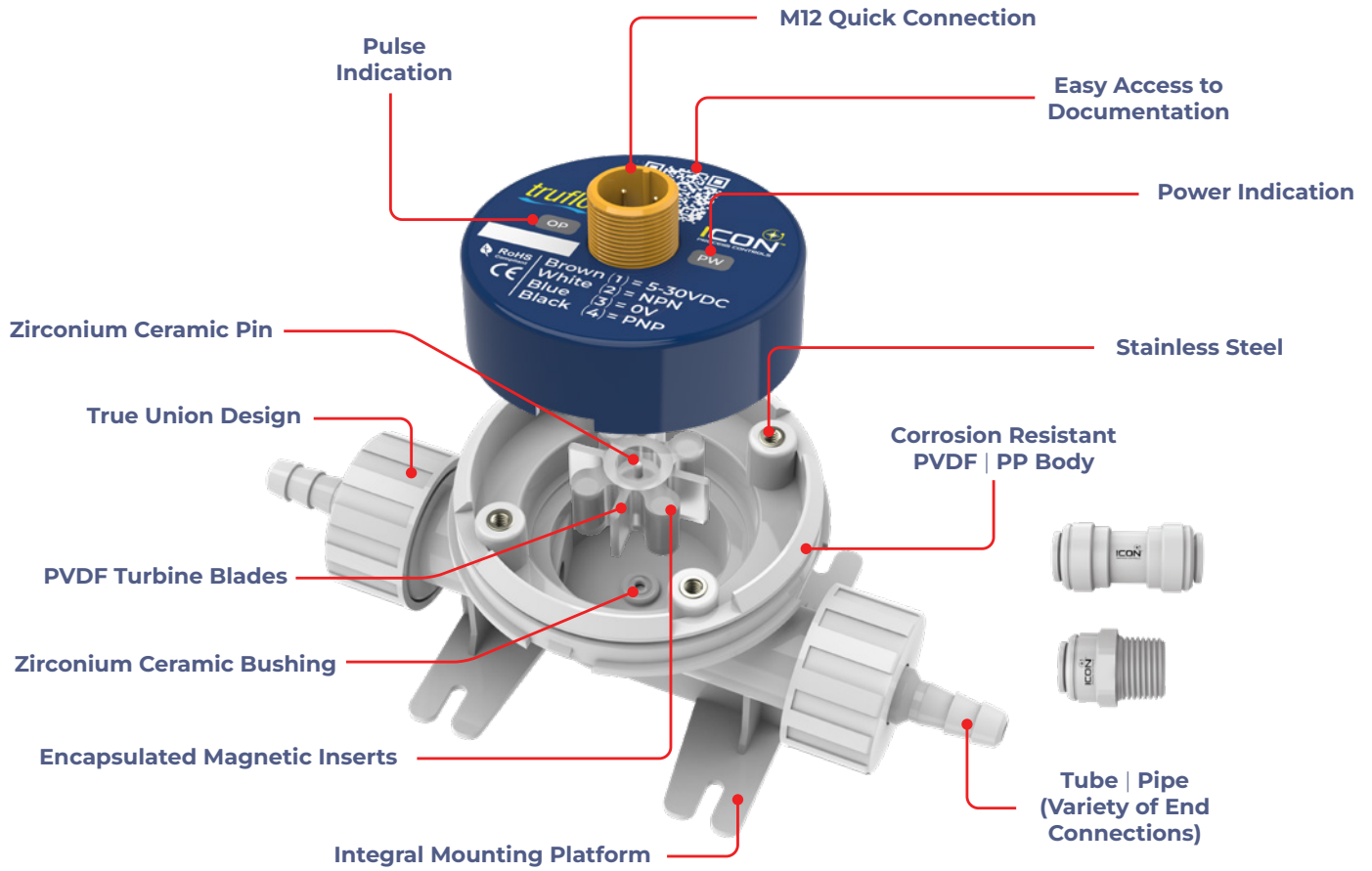

Display Functions



Keypad Functions

Press  to Change the Numerical Value

Press  to Shift the Digit

Press  to Enter into Setting Status or Load the Setting Value

Programming

STEPS	DISPLAY	RANGE	DESCRIPTION
1 Main Display   +  3 SEC		0~9999	Current Value
2 Setting of Lock  		0~99	LK = 10 : Settable
3 Filter Speed Setting  		1~99	Filter Speed, F = Display Response Rate Lower F → More smoothing (better for visual stability). Higher F → Faster reaction (better for real-time control applications).
4 Decimal Point Selection  		0~3	dP.0 = Flow Rate Meter 0 ~ 9999 dP.1 = Flow Rate Meter 0.0 ~ 999.9 dP.2 = Flow Rate Meter 0.00 ~ 99.99 dP.3 = Flow Rate Meter 0.000 ~ 9.999
5 Unit Selection  		L / KL / G / C	ut.L = LPM ut.KL = KLPM ut.G = GPM ut.C = cc/M
6 Alarm Mode Selection  		0~4	Range : ALt.0 ~ ALt.4 *Refer to the Mode of Alarm
7 Power on Delay Time  		0~99s	t.00 = Delay Time of Alarm Output (sec)

Mode of Alarm







ALt No.	Description
ALt = 0	Non-alarm
ALt = 1	$PV \geq AL \rightarrow$ Alarm ON ; $PV < SV + Hys \rightarrow$ Alarm OFF
ALt = 2	$PV \leq AL \rightarrow$ Alarm ON ; $PV > SV + Hys \rightarrow$ Alarm OFF
ALt = 3	$SV + Hys \geq PV \geq AL - Hys \rightarrow$ Alarm ON ; $PV > AL + Hys$ or $PV < SV - Hys \rightarrow$ Alarm OFF
ALt = 4	$AL + Hys \geq PV \geq AL - Hys \rightarrow$ Alarm OFF ; $PV > AL + Hys$ or $PV < SV - Hys \rightarrow$ Alarm ON

K Factor | Alarm Programming







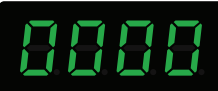

STEPS	DISPLAY	Range	OPERATION
1 Main Display 		0~9999	Current Value
2 K Factor Status 		K.0 or K.1	Coefficient for Flow Rate Meter K.0 = 0~9999; K.1 = 10000~19999
3 K Factor Setting 		0~9999 or 10000~19999	Coefficient for Flow Rate Meter K.0 Setting Range = 0~9999 K.1 Setting Range = 10000~19999
4 Alarm Setting Status 			Alarm Set Point
5 Alarm Value Setting 		0~9999	Enter Value
6 Alarm Hysteresis Setting Status 			Alarm Hysteresis
7 Alarm Hysteresis Setting 		0~9999	Enter Value *Prevents Relay Chatter

Transmitter Range Setting (4-20mA Output Models)

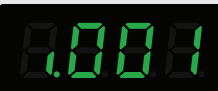
Note: Set LK 19 in Lock Settings (Refer to Page 6)

STEPS	DISPLAY	Range	OPERATION
1 Main Display 		0~9999	Current Value
2 Transmitter Range 			20mA (High) Range
3 20mA Value 		0~9999	Set 20mA - Max. Flow Rate

Setting of Communication (For RS485 Output Models)

STEPS	DISPLAY	RANGE	DESCRIPTION
1 Main Display 			Current Value
2 Id NO 		1~225	
3 Protocol 		0 or 1	<input type="checkbox"/> rs=0 : Modbus-RTU <input type="checkbox"/> rs=1 : Modbus-ASCII
4 BPS 		0~2	<input type="checkbox"/> bPS.0 : 9600 bps <input type="checkbox"/> bPS.1 : 19200 bps <input type="checkbox"/> bPS.2 : 38400 bps
5 Configuration 		0~5	1. <input type="checkbox"/> blt.0=8N1 : 8 bit non parity; 2. <input type="checkbox"/> blt.1=8O1 : 8 bit odd parity; 3. <input type="checkbox"/> blt.2=8E1 : 8 bit even parity; 4. <input type="checkbox"/> blt.3=8N2 : 8 bit non parity; 5. <input type="checkbox"/> blt.4=7O1 : 7 bit odd parity; 6. <input type="checkbox"/> blt.5=7E1 : 7 bit even parity;

Address

Address	Parameter	Description	Address	Parameter	Description	Address	Parameter	Description
00H 01H	CV	Flow Rate Value	00H 05H	HYS	Alarm Hysteresis Setting	00H 09H	ALt	Alarm Mode Setting
00H 02H	K.O	K Factor Range Selection	00H 06H	Lk	Setting of Lock	00H 0AH	t	Alarm Delay Time
00H 03H	K	K Factor	00H 07H	dP	Decimal Point Selecting	00H 0BH		Output Status*
00H 04H	AL	Alarm Value Setting	00H 08H	U t	Unit Selecting	00H 0CH		

Output Status*	
Data	Alarm
00H 00H	Off
00H 01H	On

Installation Positions

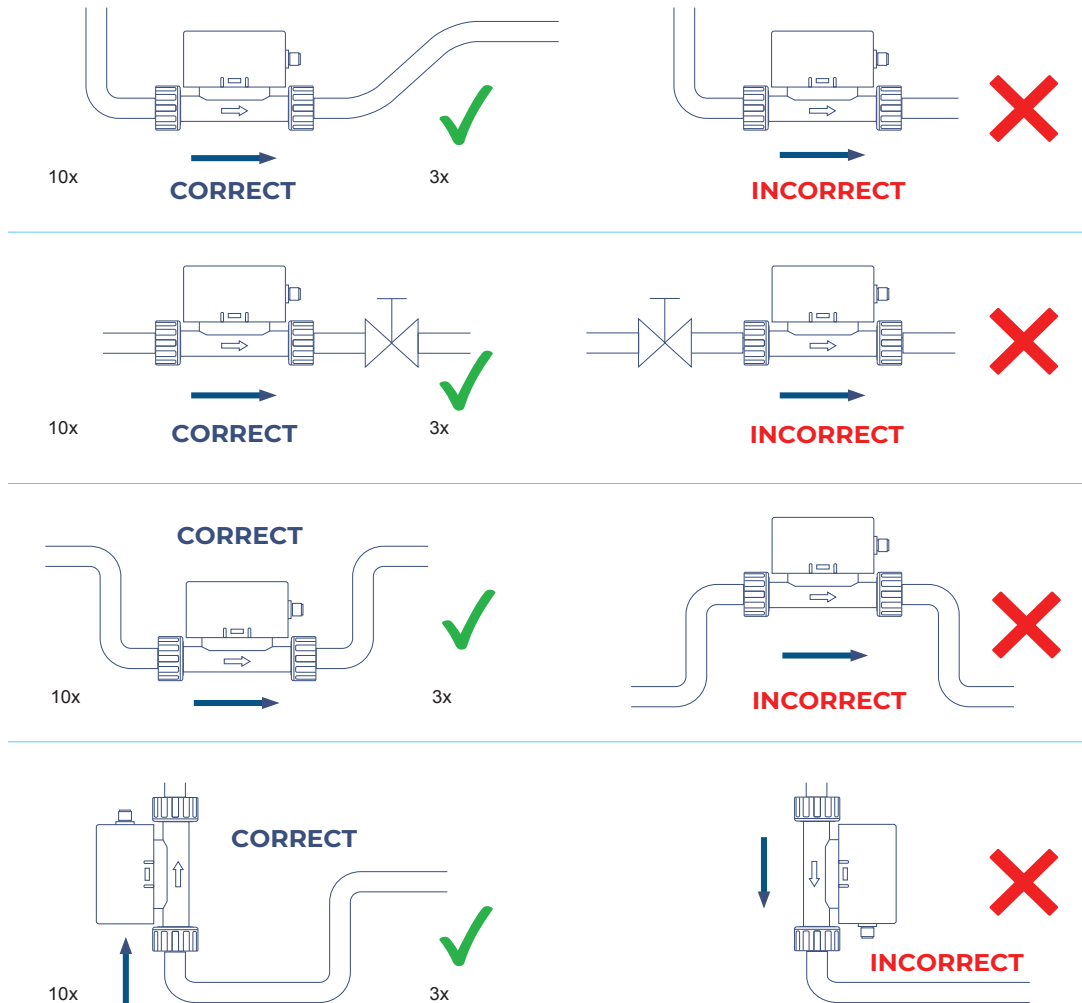

1. Make sure the measuring tube must be filled with the fluid under normal operation.
2. ProPulse® 2 Series can be installed at horizontal or vertical direction.
3. Set enough length of straight pipe to avoid the vortex might be existed.
(The minimum straight upstream must be over 10 x DN and downstream must be observed over 3 x DN)
4. Adopt filtering device in the upstream to avoid the paddle wheel from be damaged by the solids or fibers.
5. Do not flush the pipe after the measuring unit being installed, if do that may crack the ceramic shaft.

Truflo® — ProPulse® 2 Series Mini Turbine Flow Meter

Model Selection

ProPulse® 2 — Turbine Flow Meter				
Size	Display Version	Material: PP Part Number	Material: PVDF Part Number	Material: PFA Part Number
1/8" NPT	Blind: NPN PNP	PP-W-02N-PP	PP-W-02N-PF	
3/16" Hose Barb	Blind: NPN PNP	PP-W-03H-PP	PP-W-03H-PF	
1/4" Straight Tube	Blind: NPN PNP	PP-W-04T-PP	PP-W-04T-PF	
1/4" Flared	Blind: NPN PNP			PP-W-04F-PT
3/8" Straight Tube	Blind: NPN PNP	PP-W-06T-PP	PP-w-06T-PF	
3/8" Hose Barb	Blind: NPN PNP	PP-W-06H-PP	PP-W-06H-PF	
3/8" Flared	Blind: NPN PNP			PP-W-06F-PT
1/8" NPT	LED: RS485	PP-R-02N-PP	PP-R-02N-PF	
3/16" Hose Barb	LED: RS485	PP-R-03H-PP	PP-R-03H-PF	
1/4" Straight Tube	LED: RS485	PP-R-04T-PP	PP-R-04T-PF	
1/4" Flared	LED: RS485			PP-R-04F-PT
3/8" Straight Tube	LED: RS485	PP-R-06T-PP	PP-R-06T-PF	
3/8" Hose Barb	LED: RS485	PP-R-06H-PP	PP-R-06H-PF	
3/8" Flared	LED: RS485			PP-R-06F-PT
1/8" NPT	LED: 4-20mA + Pulse	PP-M-02N-PP	PP-M-02N-PF	
3/16" Hose Barb	LED: 4-20mA + Pulse	PP-M-03H-PP	PP-M-03H-PF	
1/4" Straight Tube	LED: 4-20mA + Pulse	PP-M-04T-PP	PP-M-04T-PF	
1/4" Flared	LED: 4-20mA + Pulse			PP-M-04F-PT
3/8" Straight Tube	LED: 4-20mA + Pulse	PP-M-06T-PP	PP-M-06T-PF	
3/8" Hose Barb	LED: 4-20mA + Pulse	PP-M-06H-PP	PP-M-06H-PF	
3/8" Flared	LED: 4-20mA + Pulse			PP-M-06F-PT

ProPulse® 2 — Transition Fittings		
Version	Part Number	Material
1/4" Tube x Tube	PP2-T14T14-PP	PP
3/8" Tube x Tube	PP2-T38T38-PP	PP
1/4" Tube x 3/8" NPT	PP2-T14N38-PP	PP
3/8" Tube x NPT	PP2-T38N38-PP	PP
3/8" Tube x 1/2" NPT	PP2-T38N12-PP	PP
1/4" Tube x Tube	PP2-T14T14-PF	PVDF
3/8" Tube x Tube	PP2-T38T38-PF	PVDF
1/4" Tube x 3/8" NPT	PP2-T14N38-PF	PVDF
3/8" Tube x 3/8" NPT	PP2-T38N38-PF	PVDF
3/8" Tube x 1/2" NPT	PP2-T38N12-PF	PVDF



Warranty, Returns and Limitations

Warranty

Icon Process Controls Ltd warrants to the original purchaser of its products that such products will be free from defects in material and workmanship under normal use and service in accordance with instructions furnished by Icon Process Controls Ltd for a period of one year from the date of sale of such products. Icon Process Controls Ltd obligation under this warranty is solely and exclusively limited to the repair or replacement, at Icon Process Controls Ltd option, of the products or components, which Icon Process Controls Ltd examination determines to its satisfaction to be defective in material or workmanship within the warranty period. Icon Process Controls Ltd must be notified pursuant to the instructions below of any claim under this warranty within thirty (30) days of any claimed lack of conformity of the product. Any product repaired under this warranty will be warranted only for the remainder of the original warranty period. Any product provided as a replacement under this warranty will be warranted for the one year from the date of replacement.

Returns

Products cannot be returned to Icon Process Controls Ltd without prior authorization. To return a product that is thought to be defective, go to www.iconprocon.com, and submit a customer return (MRA) request form and follow the instructions therein. All warranty and non-warranty product returns to Icon Process Controls Ltd must be shipped prepaid and insured. Icon Process Controls Ltd will not be responsible for any products lost or damaged in shipment.

Limitations

This warranty does not apply to products which:

1. are beyond the warranty period or are products for which the original purchaser does not follow the warranty procedures outlined above;
2. have been subjected to electrical, mechanical or chemical damage due to improper, accidental or negligent use;
3. have been modified or altered;
4. anyone other than service personnel authorized by Icon Process Controls Ltd have attempted to repair;
5. have been involved in accidents or natural disasters; or
6. are damaged during return shipment to Icon Process Controls Ltd

Icon Process Controls Ltd reserves the right to unilaterally waive this warranty and dispose of any product returned to Icon Process Controls Ltd where:

1. there is evidence of a potentially hazardous material present with the product;
2. or the product has remained unclaimed at Icon Process Controls Ltd for more than 30 days after Icon Process Controls Ltd has dutifully requested disposition.

This warranty contains the sole express warranty made by Icon Process Controls Ltd in connection with its products. ALL IMPLIED WARRANTIES, INCLUDING WITHOUT LIMITATION, THE WARRANTIES OF MERCHANTABILITY AND FITNESS FOR A PARTICULAR PURPOSE, ARE EXPRESSLY DISCLAIMED. The remedies of repair or replacement as stated above are the exclusive remedies for the breach of this warranty. IN NO EVENT SHALL Icon Process Controls Ltd BE LIABLE FOR ANY INCIDENTAL OR CONSEQUENTIAL DAMAGES OF ANY KIND INCLUDING PERSONAL OR REAL PROPERTY OR FOR INJURY TO ANY PERSON. THIS WARRANTY CONSTITUTES THE FINAL, COMPLETE AND EXCLUSIVE STATEMENT OF WARRANTY TERMS AND NO PERSON IS AUTHORIZED TO MAKE ANY OTHER WARRANTIES OR REPRESENTATIONS ON BEHALF OF Icon Process Controls Ltd. This warranty will be interpreted pursuant to the laws of the province of Ontario, Canada.

If any portion of this warranty is held to be invalid or unenforceable for any reason, such finding will not invalidate any other provision of this warranty.

For additional product documentation and technical support visit:

www.iconprocon.com | e-mail: sales@iconprocon.com or support@iconprocon.com | Ph: 905.469.9283



by



Corrosion-Free
Instrumentation Equipment

Phone: 905.469.9283 · **Sales:** sales@iconprocon.com · **Support:** support@iconprocon.com